



PHILIPS

PrimeSet

LED display
modules

LDM521
Vision

Technical leaflet

Island lighting

Lighting food. Brightening faces.

Philips LED lighting for refrigeration cases is a sustainable and energy-efficient way to create an enjoyable shopping experience for customers – while at the same time supporting retailers' brand values. Thanks to their compact design, the modules can be aesthetically integrated in the cabinet design. The modules' unique optical system directs the light in such a way that the products on display are presented uniformly, while reducing glare and dark spots.

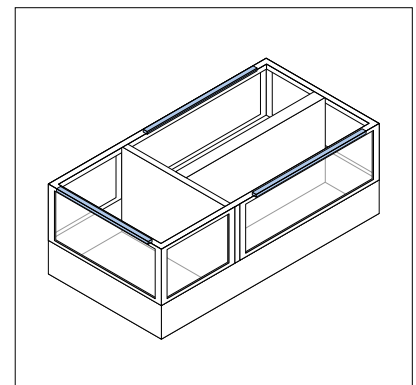

www.philips.com/ledrefrigeration



- Continuous line of light.
- Improved visibility and presentation of the merchandise in the island freezer; uniform light distribution throughout the entire cabinet.
- Improved Total Cost of Ownership by lower power consumptions.
- Lifetime of the modules, in combination with a Philips LED power driver, is rated at 50,000 hours (70% lumen maintenance).





Ideal for **horizontal integration** in island cabinets.”



Environment

Significantly improved sustainability due to lower energy consumption, reduced waste and elimination of hazardous substances such as mercury and lead.

Product features

- The range includes Vision for high lighting levels (1500 lux).
- Energy savings up to 25% compared with LDM421.
- Superb optical properties due to narrow, symmetrical beam angle of 30°.
- Products are dimmable.
- 5-year Philips warranty for the modules in combination with the Philips LED power driver.

PrimeSet LDM521 Vision

Specifications

- The rated average life of the module, in combination with a Philips LED power driver, is B50L70 at 50,000 hours (70% lumen maintenance). This rated average life is based on three switching cycles per day.
- Operating temperature (performances) min -30 °C / max +30 °C.
- Storage temperature min -30 °C / max +60 °C.
- Housing color: Aluminium
- Safety Extra Low Voltage (SELV).
- Compliance and approval; ENEC, UL, CE, Product safety class III, WEEE, EU directive 2002/95/EC, CSA, RoHS, REACH.
- The color consistency of the 830 and 840 modules is 5 SDCM.
- Instant start-up with full illumination.
- The Power Factor with Philips LED Power driver is > 0.9.
- Typical peak intensity: 730cd/1000lm
- Energy efficiency label: A+

Light distribution

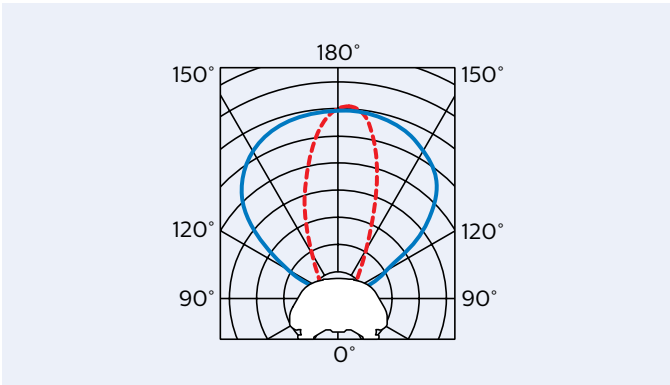

Spectral power distribution

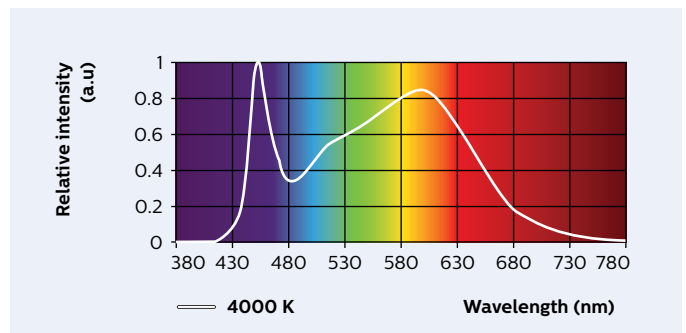
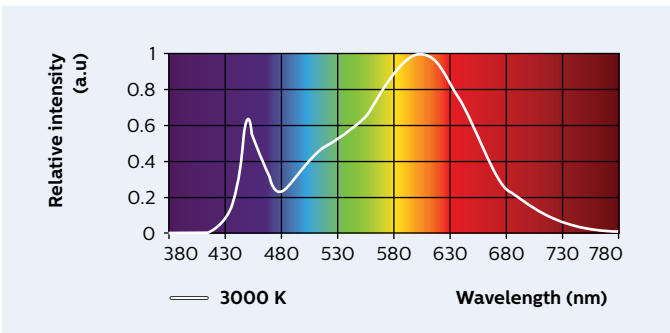

Chromaticity coordinates

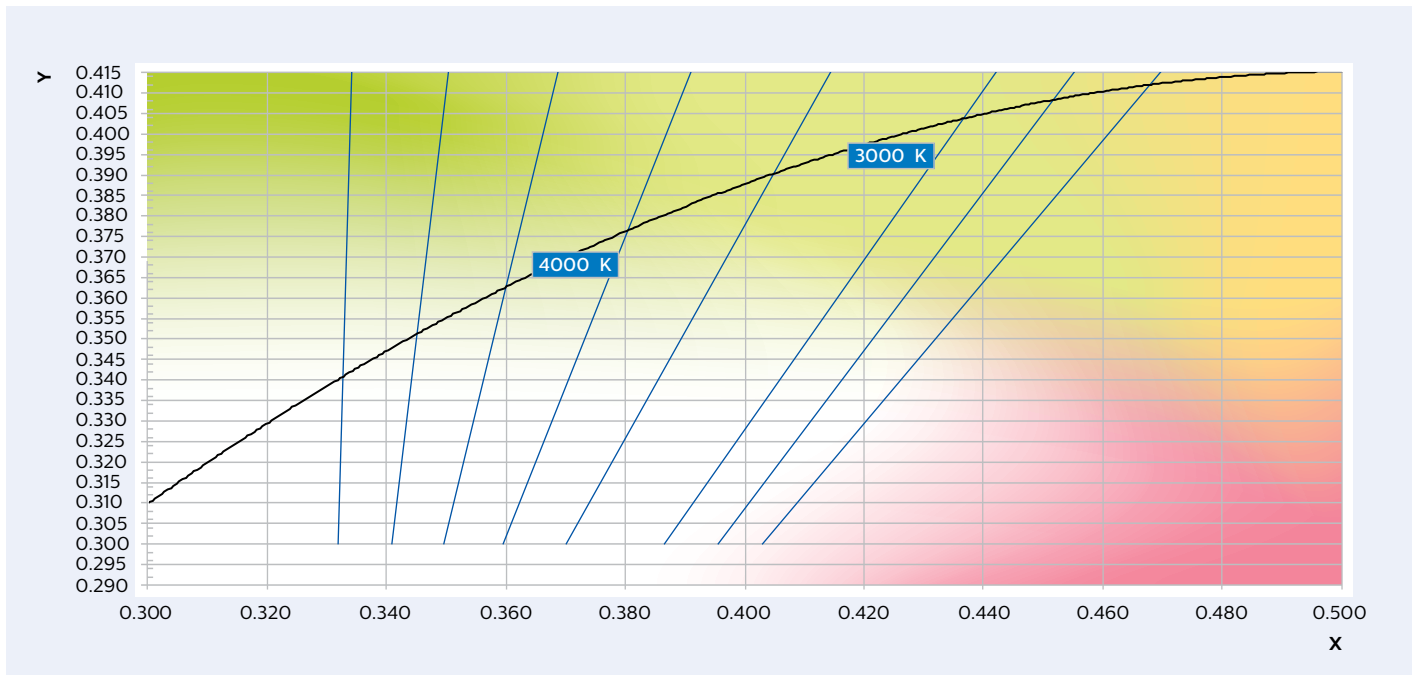

Lumen Maintenance

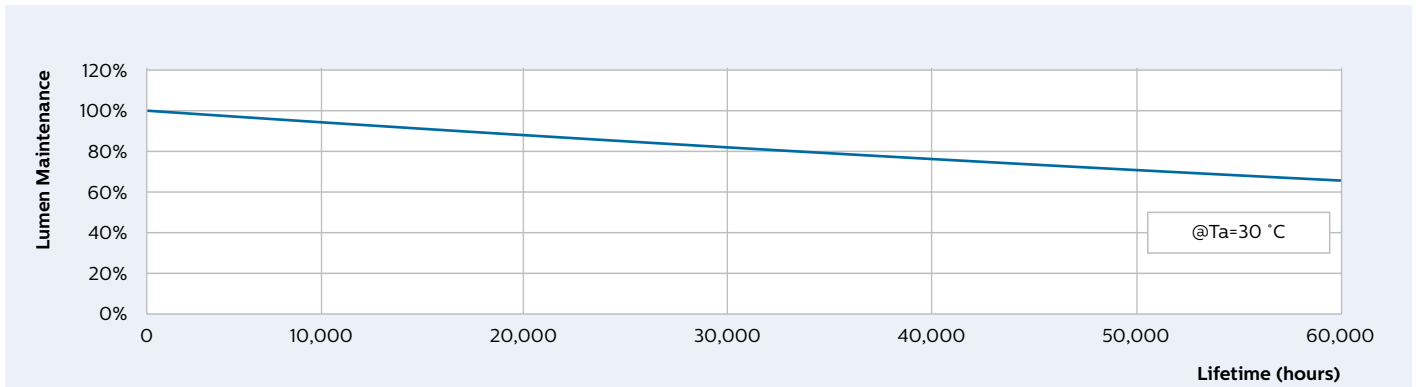

Technical Specifications

Product type	Lenght	Light color	Rated power	Rated luminous flux (lumen) ±20%	Illuminance	Color Rendering Index	Correlated Color Temperature	Typical Color coordinates*
	mm		W	lm	Lux	CRI	K	CIEx, CIey
PrimeSet LDM521 Vision 850mm (33") 830	850	Warm White	15	1600	1500	85	3000	0.4255, 0.3965
PrimeSet LDM521 Vision 850mm (33") 840	850	Neutral White	15	1600	1500	85	4000	0.3741, 0.3718
PrimeSet LDM521 Vision 1175mm (46") 830	1175	Warm White	20	2100	1500	85	3000	0.4255, 0.3965
PrimeSet LDM521 Vision 1175mm (46") 840	1175	Neutral White	20	2200	1500	85	4000	0.3741, 0.3718

* Measurement tolerance is ± 0.007

Note:

Daisy chain length: max 3 modules in a row.

Cable length between driver and module: max 5 m.

Dimensions PrimeSet LDM521 Vision

Type	A1	A3	B1	C1
PrimeSet LDM521 Vision 850mm (33")	850	860	34	22
PrimeSet LDM521 Vision 1175mm (46")	1175	1185	34	22

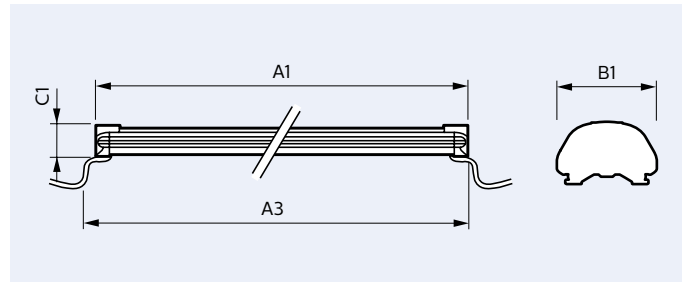

LED power driver



Power supply: Philips LED power driver

Philips Affinium LED display modules are only suitable for connection to a circuit from a class 2 power source with a limited energy supply. We have developed a LED power driver which is ideal for powering the PrimeSet modules.

To allow for variance in the installation, we recommend you do not load the power driver beyond 80% (20 W, 80 W and 100 W driver) of its rated maximum power. Please refer to the wiring diagram in the installation guide for more details.

Dimensions LED power driver

Type	A	B	C
Constant Voltage Outdoor LED driver 20W 24V	150	36	27
Constant Voltage Outdoor LED driver 80W 24V	241	43	30
Constant Voltage Outdoor LED driver 100W 24V	241	43	30



Xitanium Constant Voltage Outdoor driver 80 W and 100 W

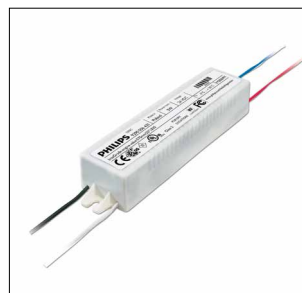
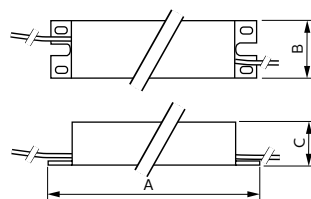

Xitanium Constant Voltage Outdoor driver 20 W

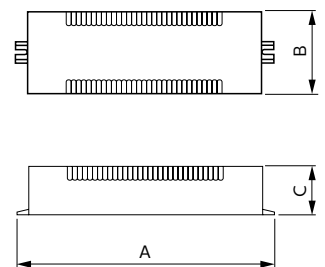

Accessories

Mounting profiles with options for glare shielding

Our new mounting profiles make it easy to install the modules. Thanks to the 'click-in' feature, the installation time is shortened considerably. We recommend the use of Mounting profile 10°. This profile is ideal for fixing under the cabinet at a 10° angle, ensuring an optimal lighting distribution. Please contact Philips for advice and availability if you need mounting profiles for specific cabinet types.

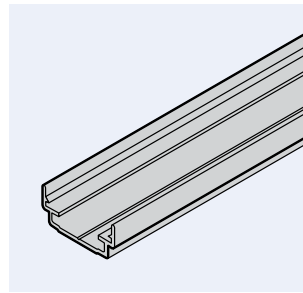

Mounting profile standard

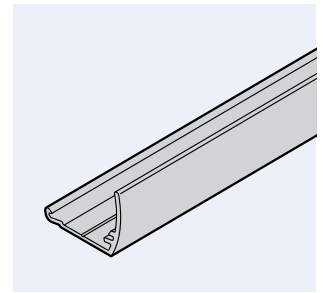

Mounting profile side 10°

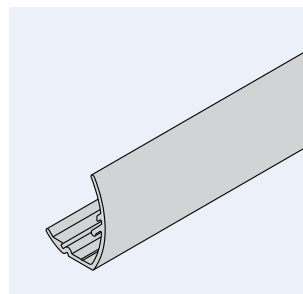

Mounting profile side 45°

Dimensions mounting profile

Type	A	B	C
PrimeSet LDM-mounting profile standard			
Mounting profile 850mm	800	34	15
Mounting profile 1175mm	1200	34	15
PrimeSet LDM-mounting profile 10°			
Mounting profile 10° 850mm	900	36	28
Mounting profile 10° 1175mm	1250	36	28
PrimeSet LDM-mounting profile 45°			
Mounting profile 45° 850mm	950	33	44
Mounting profile 45° 1175mm	1200	33	44

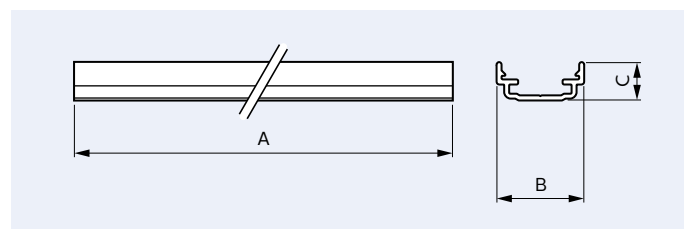

Mounting profile standard

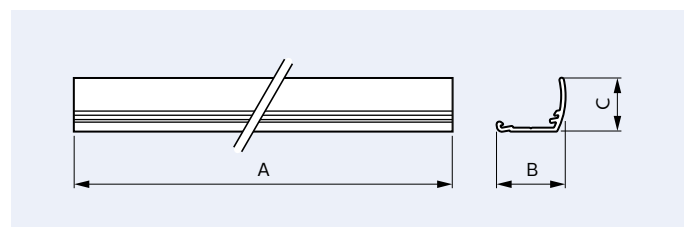

Mounting profile side 10°

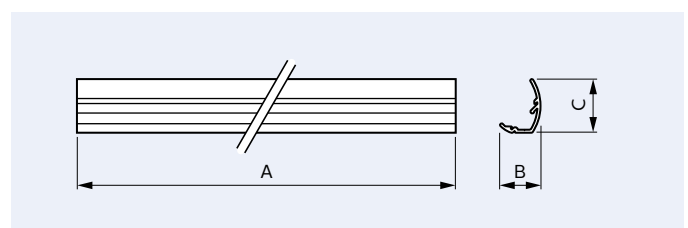

Mounting profile side 45°

Ordering information

PrimeSet LDM521 Vision

Type	Minimum order quantity (per box)	Ordering code
PrimeSet LDM521 Vision 850mm (33") 830	6	9290 009 67006
PrimeSet LDM521 Vision 850mm (33") 840	6	9290 009 66906
PrimeSet LDM521 Vision 1175mm (46") 830	6	9290 009 66806
PrimeSet LDM521 Vision 1175mm (46") 840	6	9290 009 66706

Accessories: Mounting profiles

PrimeSet LDM-mounting profile standard

PrimeSet LDM-mounting profile 850mm	12	9290 009 77206
PrimeSet LDM-mounting profile 1175mm	12	9290 009 77306

PrimeSet LDM-mounting profile 10°

PrimeSet LDM-mounting profile 10° 850mm	12	9290 009 77806
PrimeSet LDM-mounting profile 10° 1175mm	12	9290 009 78006

PrimeSet LDM-mounting profile 45°

PrimeSet LDM-mounting profile 45° 850mm	12	9290 009 77506
PrimeSet LDM-mounting profile 45° 1175mm	12	9290 009 77606

Xitanium Outdoor LED Power Driver

Type	Minimum order quantity (per box)	Ordering code
Constant Voltage Outdoor LED driver 20W 24V	10	9290 006 54006
Constant Voltage Outdoor LED driver 80W 24V	10	9290 006 53906
Constant Voltage Outdoor LED driver 100W 24V	10	9137 006 21091

